

NATIONAL UNIVERSITY OF SINGAPORE

CS2100 – COMPUTER ORGANISATION

(Semester 2: AY2016/17)

ANSWER BOOKLET

Time Allowed: 2 Hours

INSTRUCTIONS TO CANDIDATES

1. This answer booklet consists of **TWELVE (12)** printed pages.
2. Fill in your Student Number **with a pen clearly** below.
3. You may write your answers in pencil (2B or above).

STUDENT NUMBER
(fill in with a pen):

A									
----------	--	--	--	--	--	--	--	--	--

For examiner's use only		
<i>Question</i>	<i>Total</i>	<i>Marks</i>
Q1	10	
Q2	10	
Q3	10	
Q4	35	
Q5	15	
Q6	20	
Total	100	

Write your answers in the box/space provided.

1a.
[2]

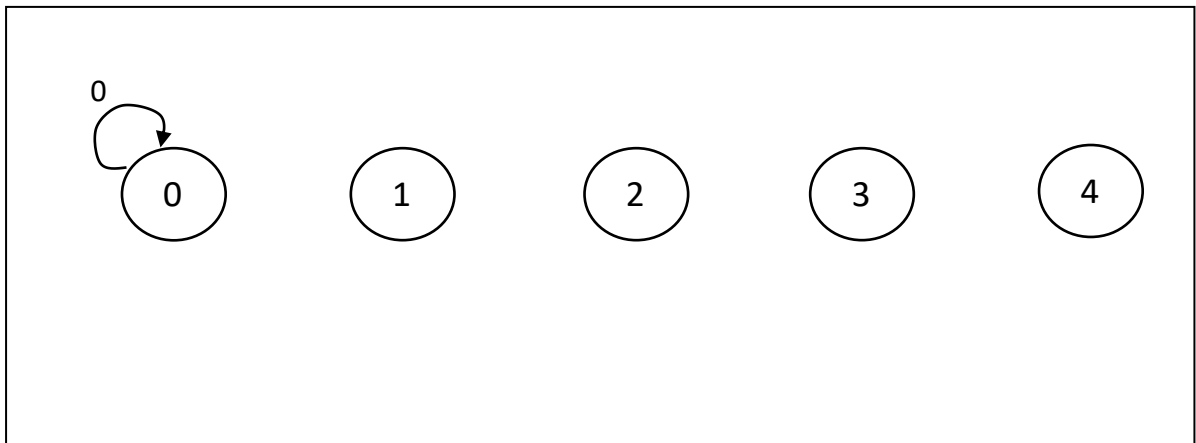

1b.
[8]

DA =

TB =

JC =

KC =

Marks for Q1:

/10

2a.
[5]

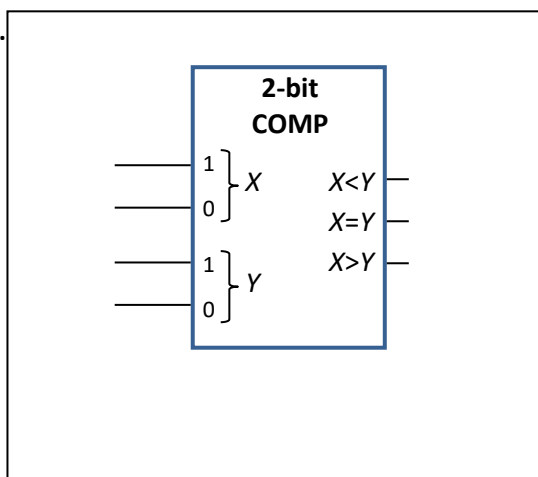

2b.
[5]

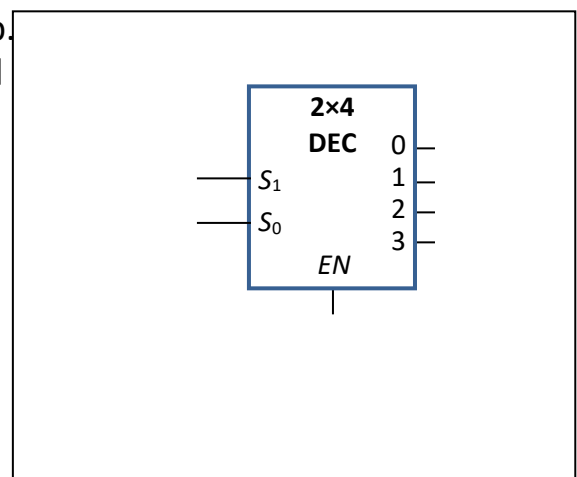

Marks for Q2:

/10

3a.
[2]

--

3b.
[2]

--

3c.
[2]

--

3d.
[4]

Array A:

--	--	--	--	--	--	--	--	--	--

Array B:

--	--	--	--	--	--	--	--	--	--

Marks for Q3:

/10

4a.
[5]

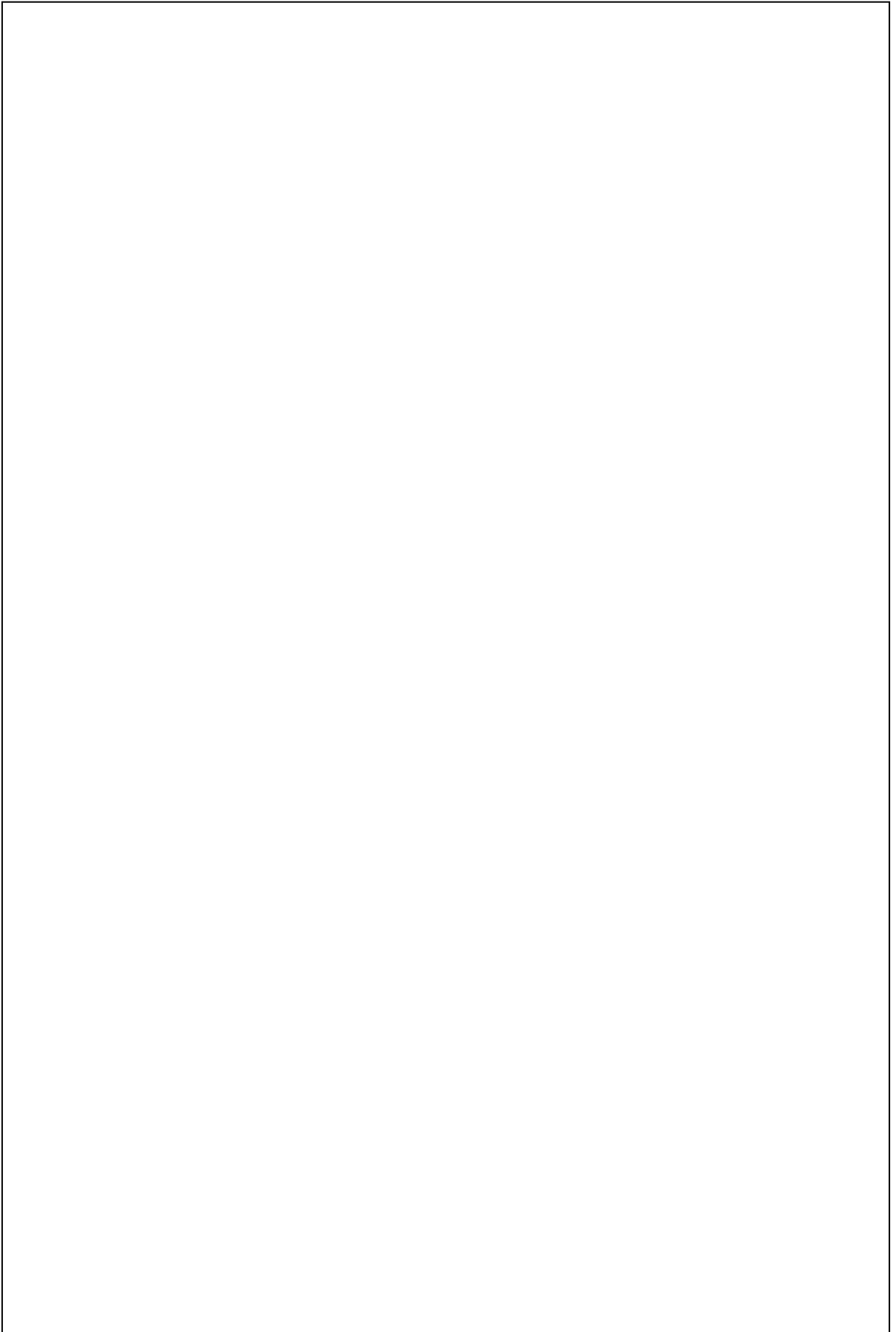

4b.
[12]

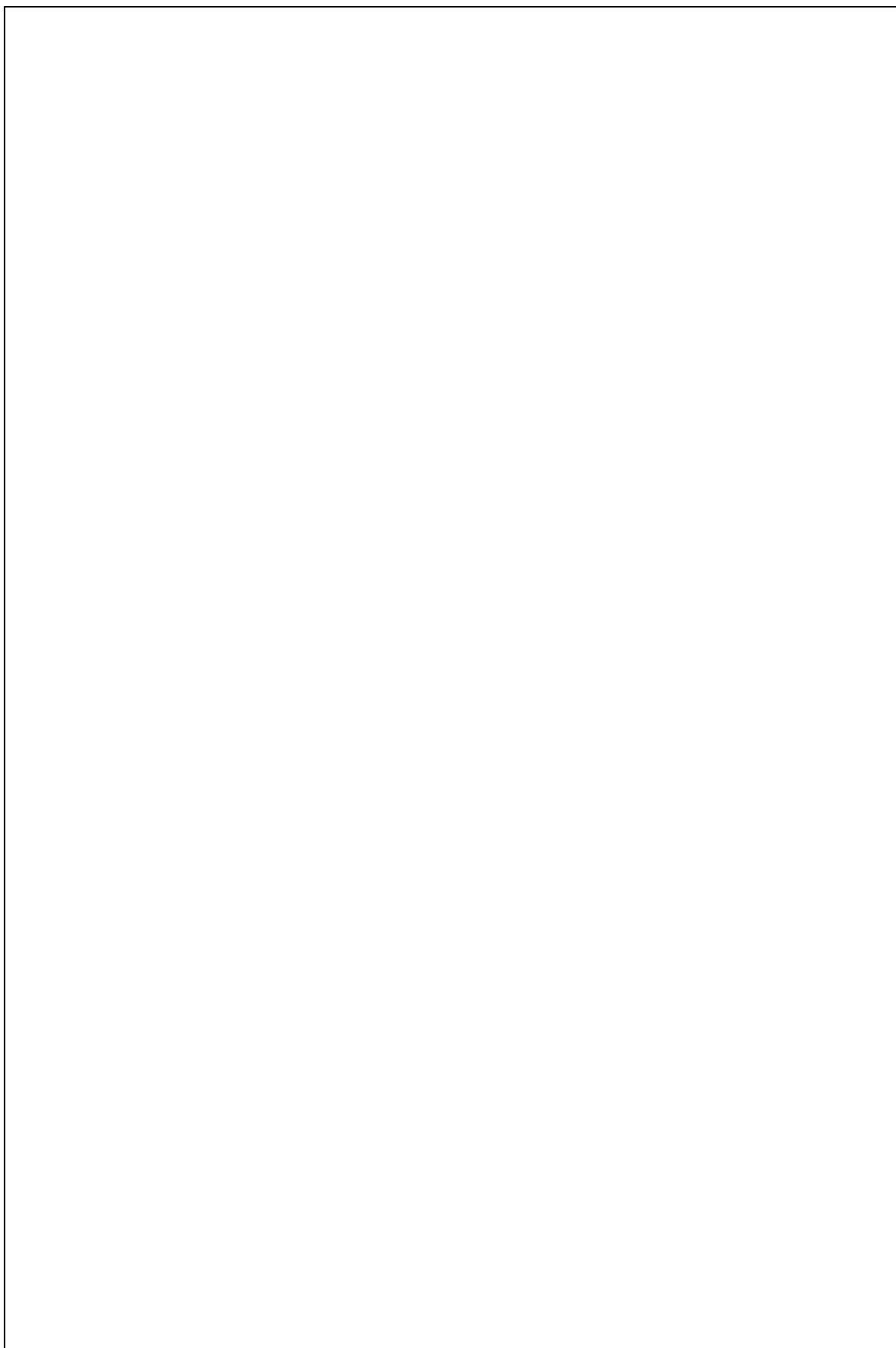

4c.
[5]

4d.
[5]

4e.
[2]

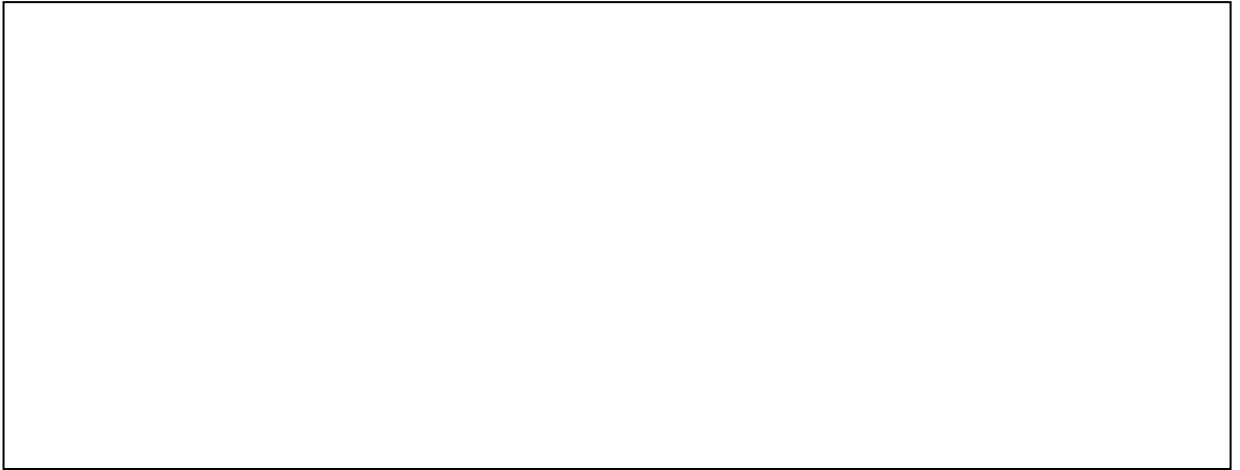

4f.
[3]



4g.
[3]



5a.
[4]

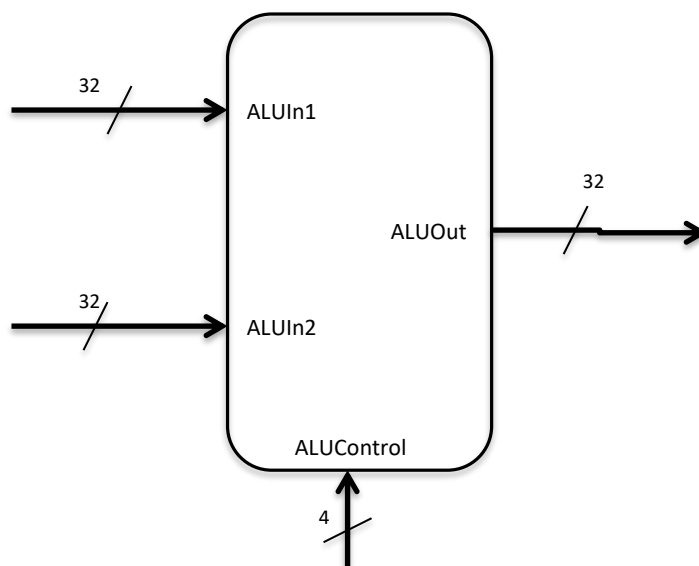

5b.
[5]

A large empty rectangular box, likely intended for a student to draw or write a solution for part 5b.

5c.
[6]

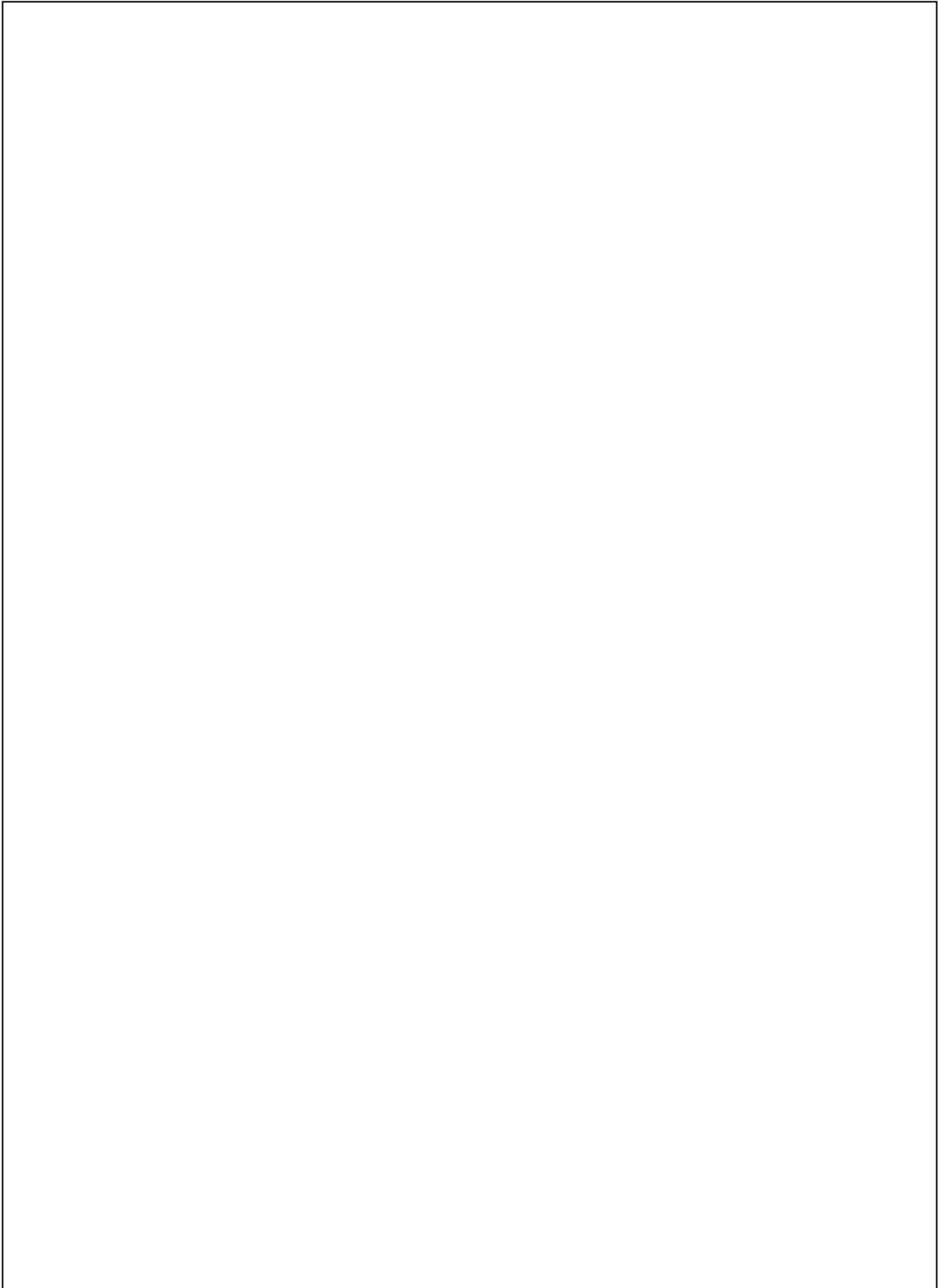

Marks for Q5: /15

6a.
[2]

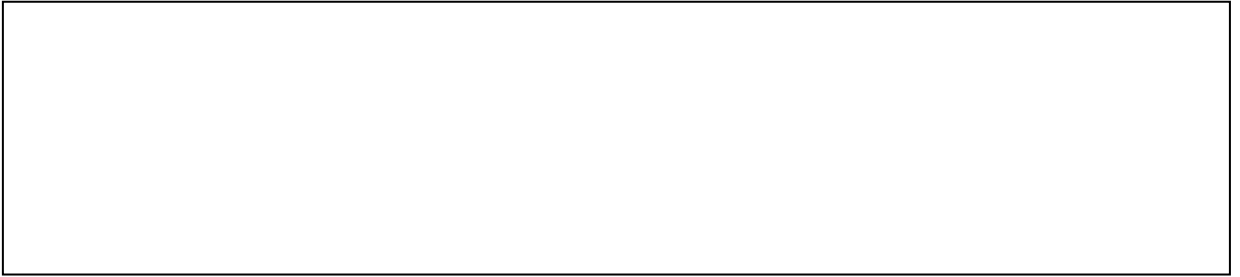

6b.
[3]



6c.
[5]



6d.
[4]



6e.
[6]

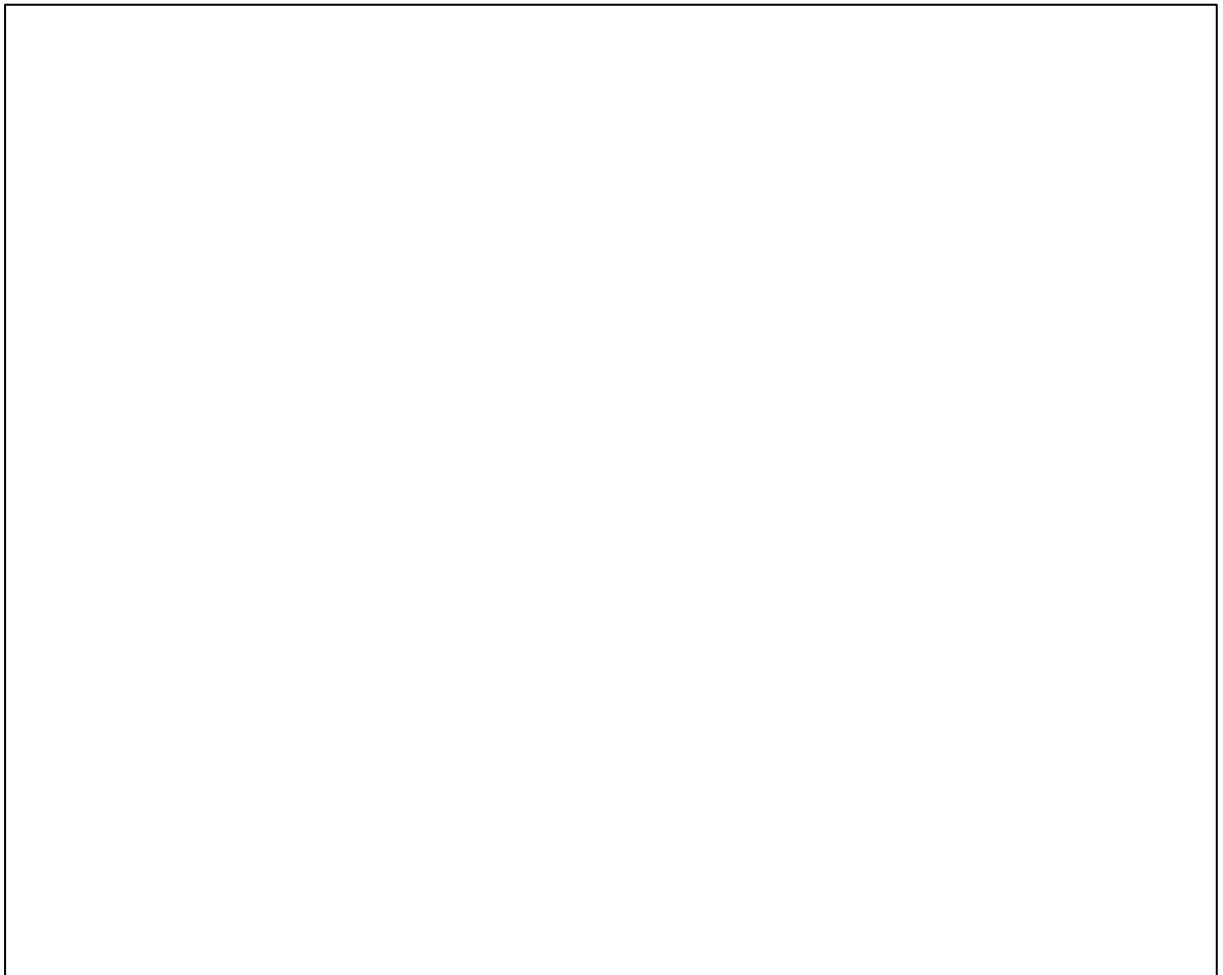

=== END OF PAPER ===